

ワクワクルはかせ

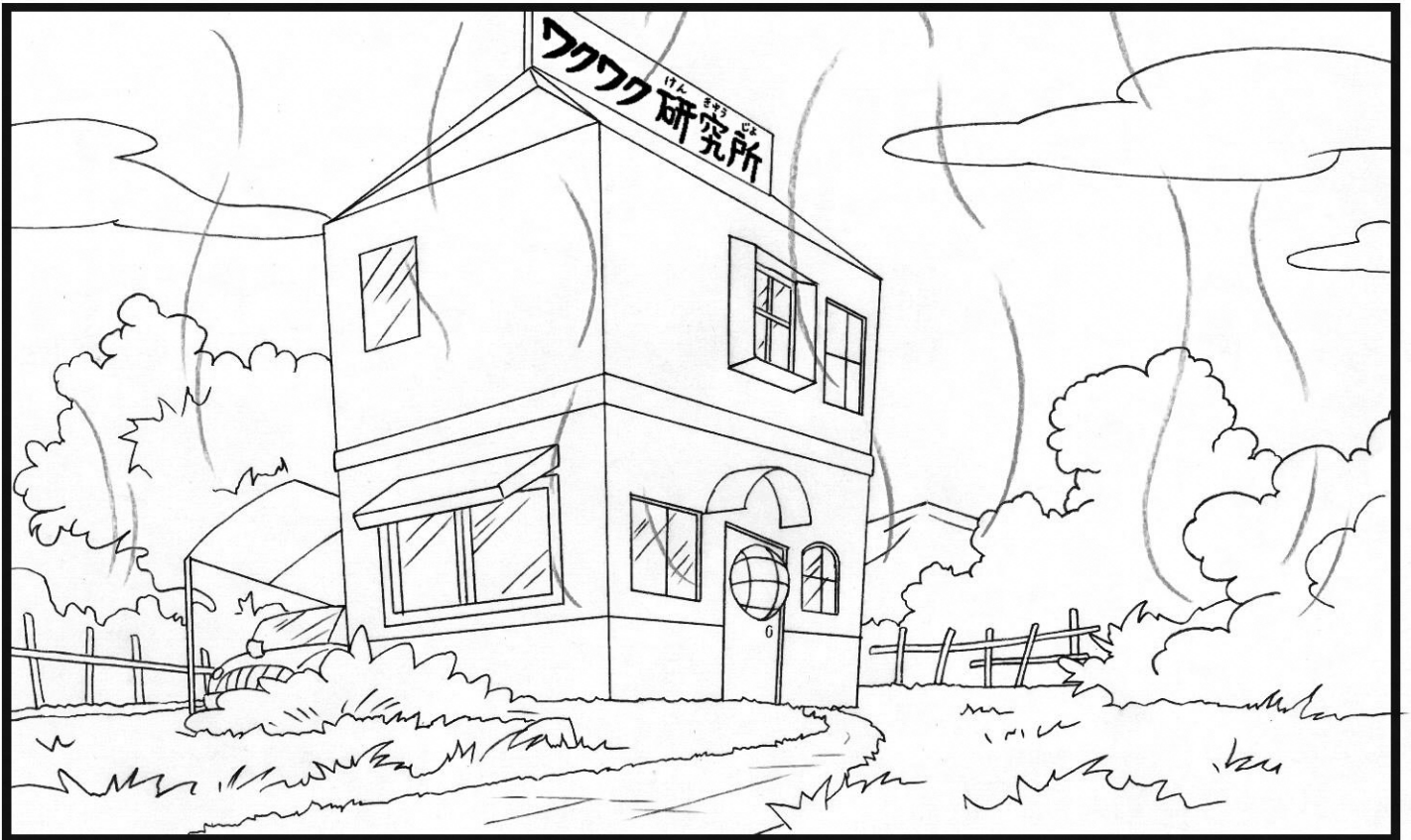

さく
作・イイムラカズオ

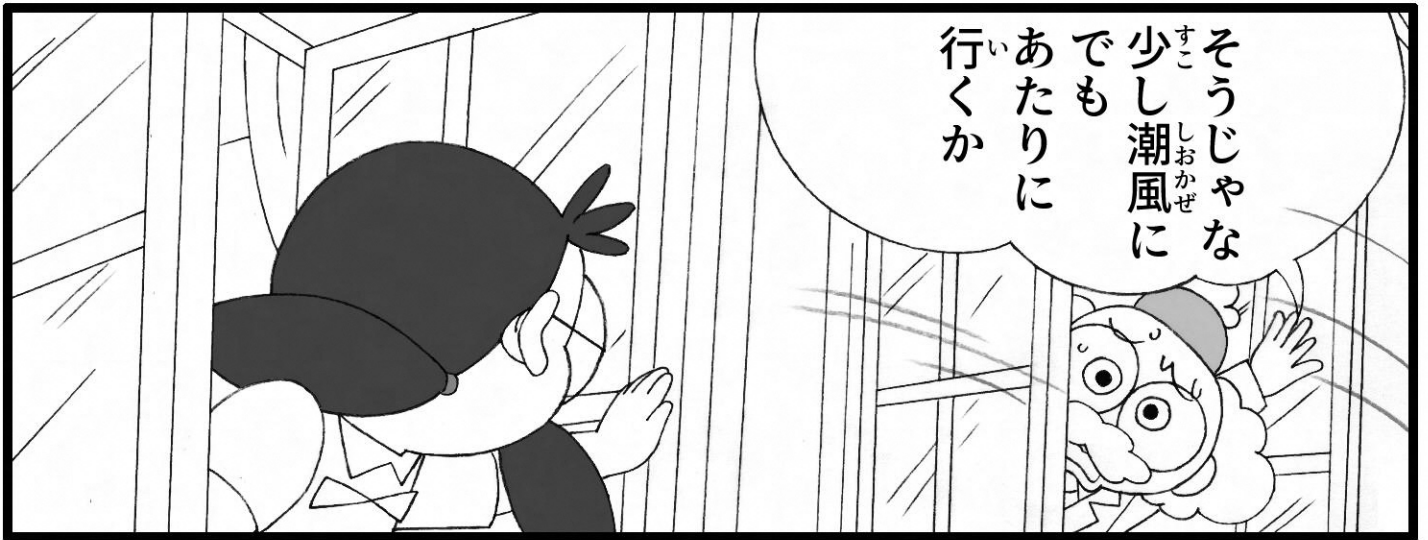

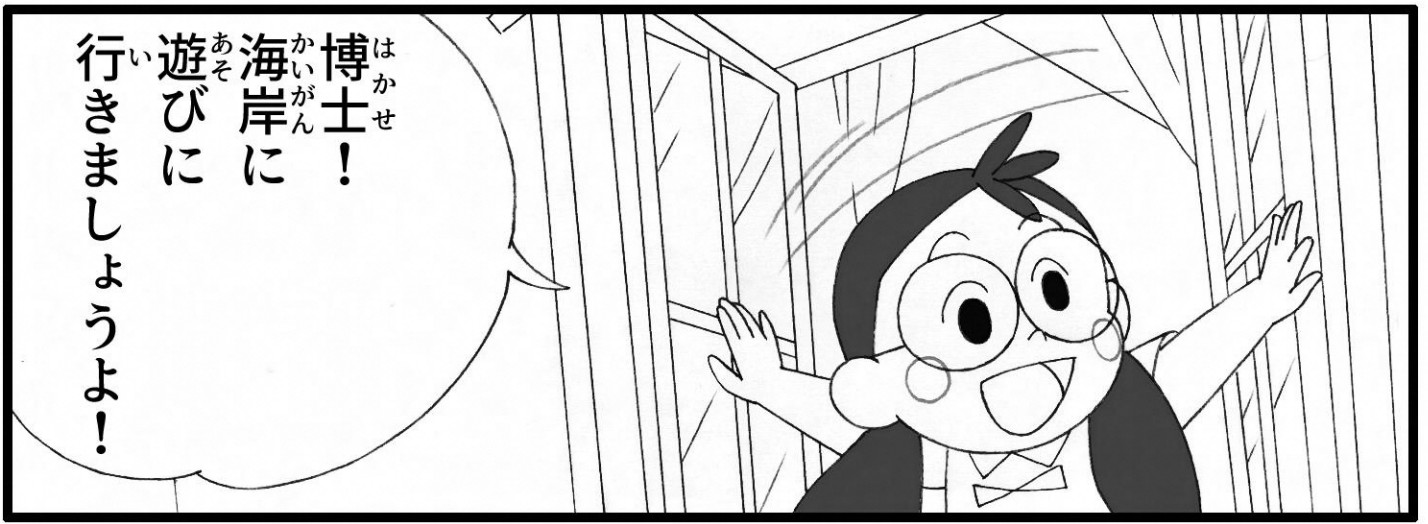

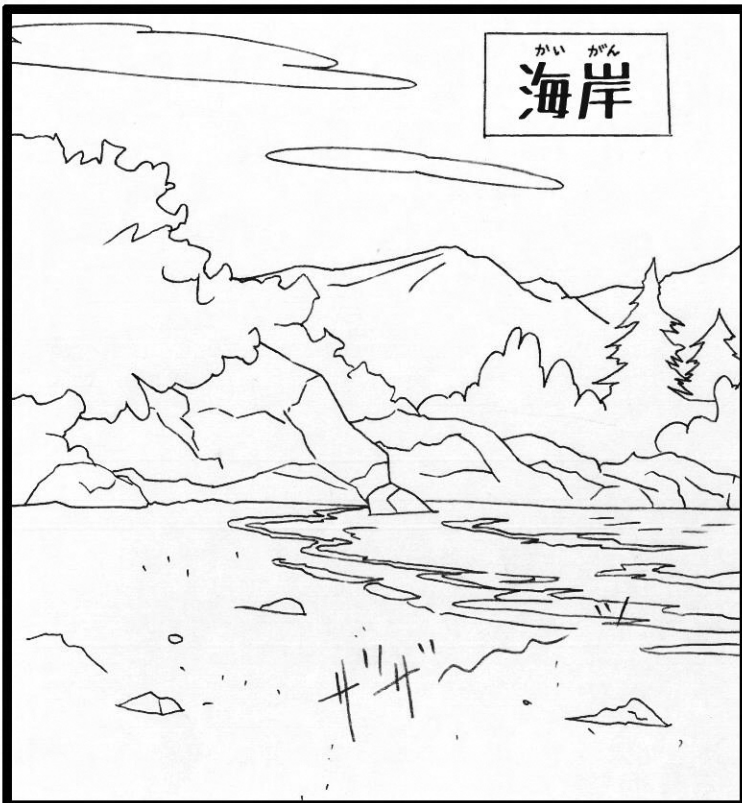

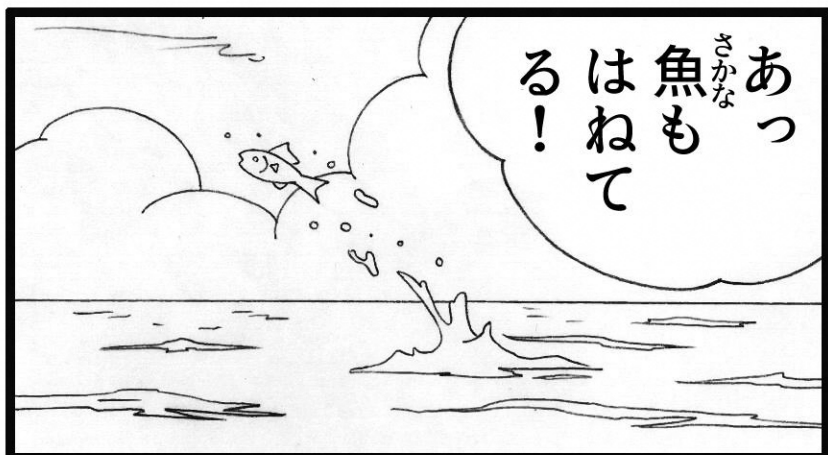
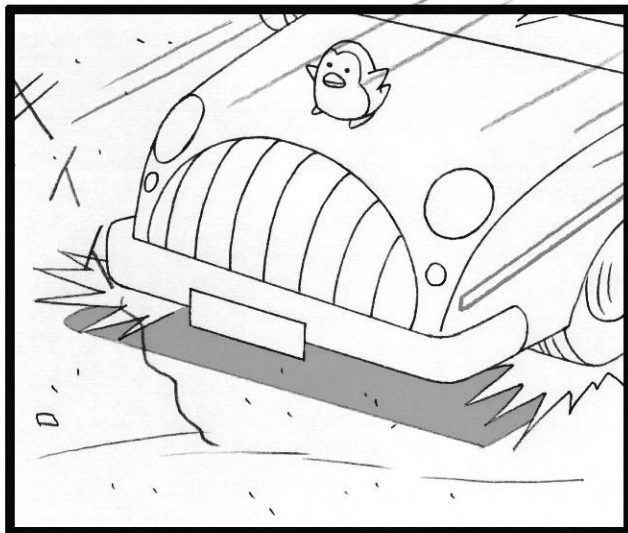
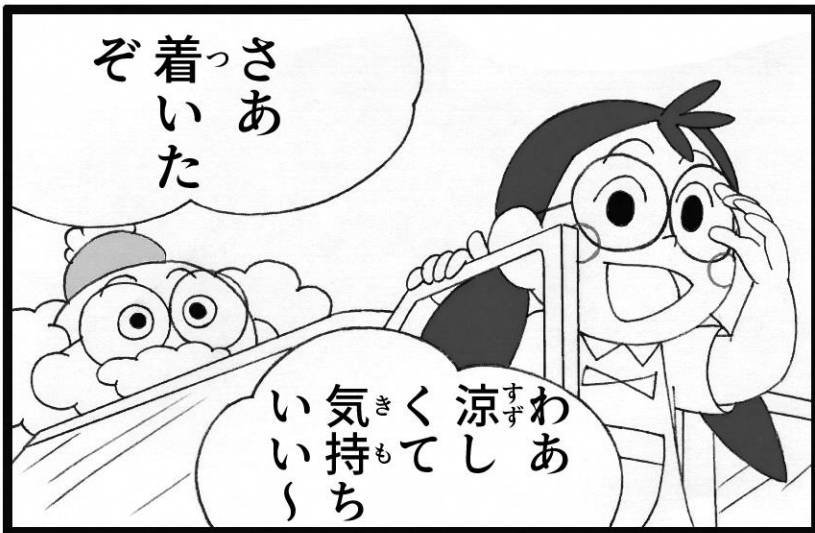



せっせ!
せっせ!
せっせ!



サフッ!

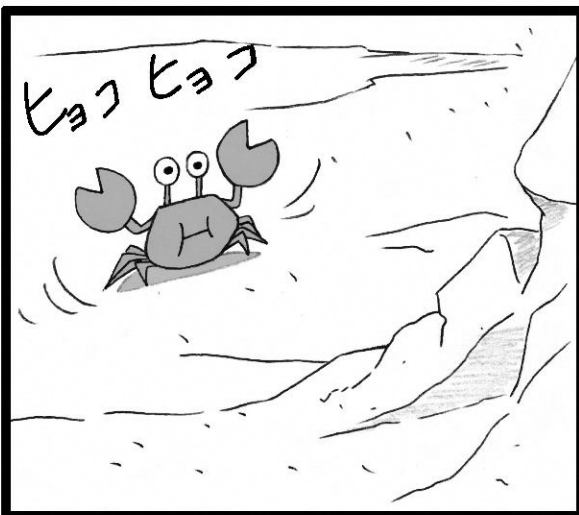

ヒョフヒョフ

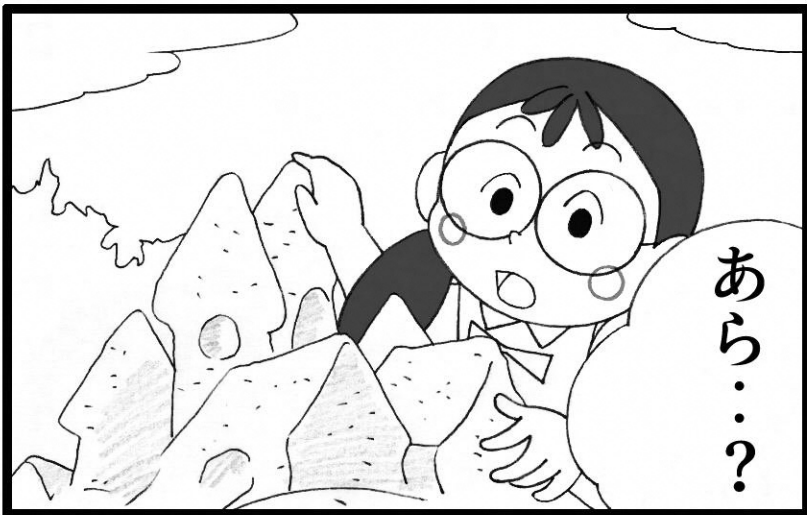

あら...?



ふむ
かわい
のう



はかせ
博士!
カニさんよ



このお城しろに
カニさんが
住すんでくれる
かなあ



ねえ
はかせ
博士

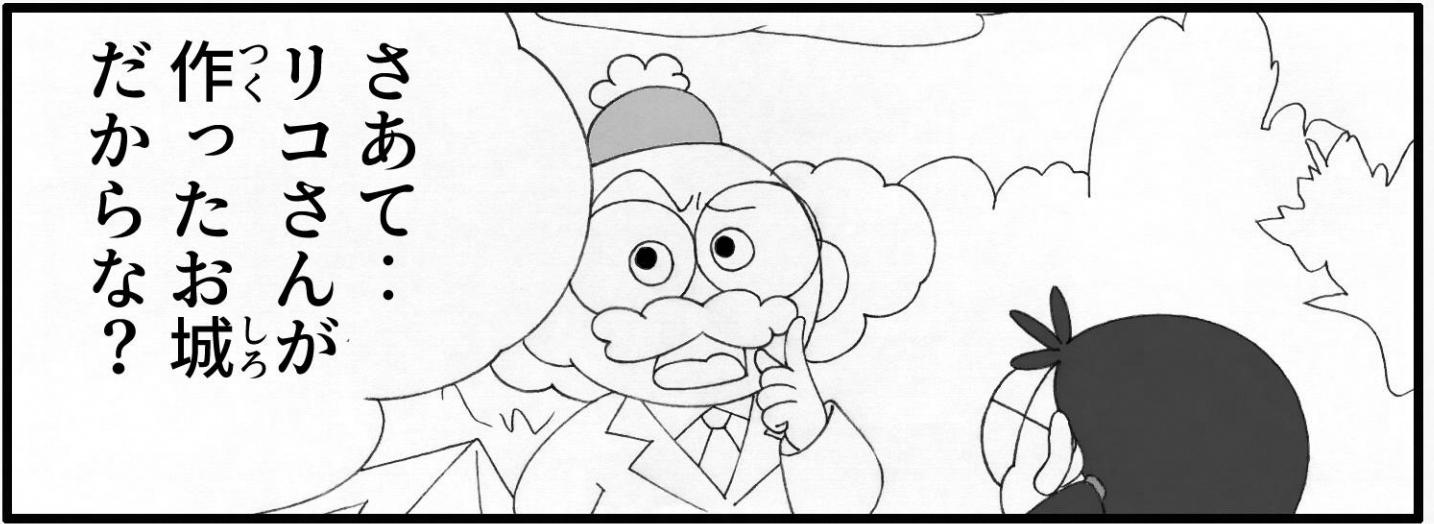



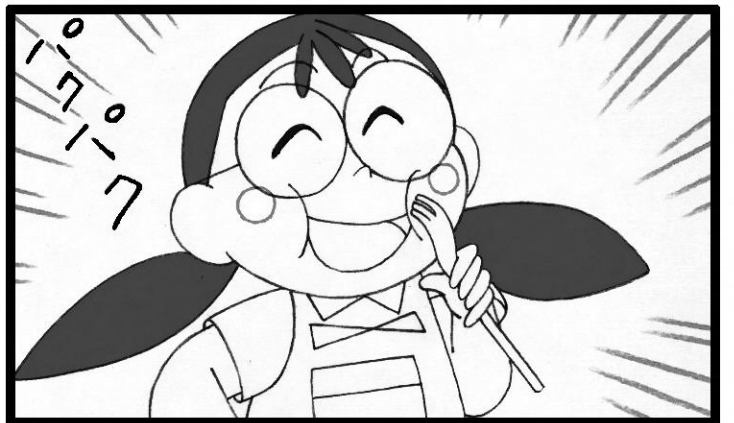
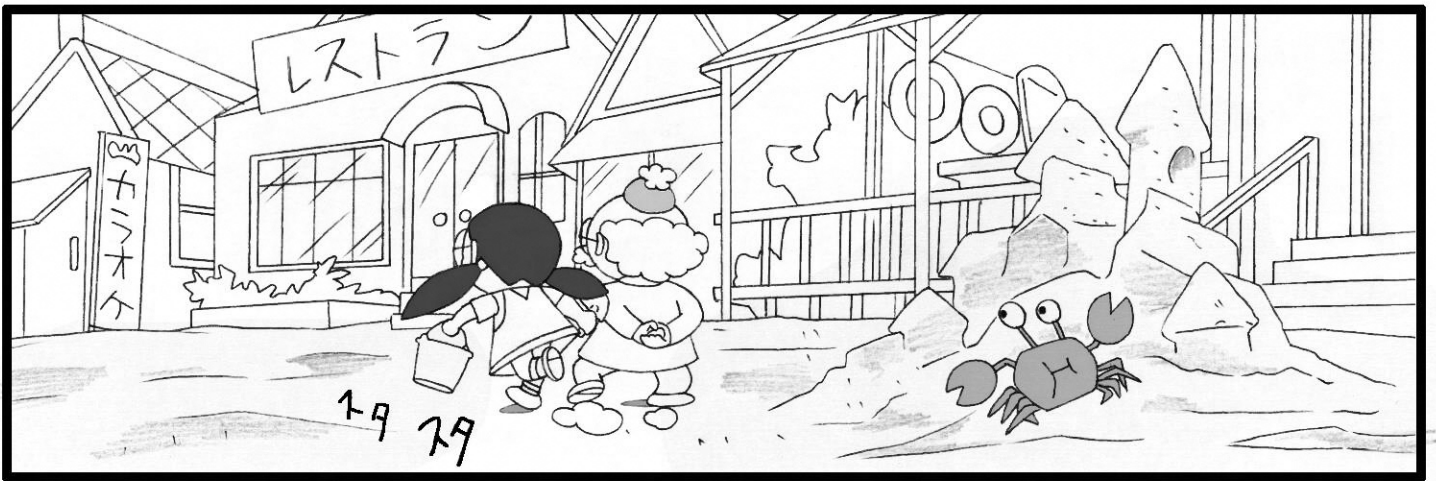

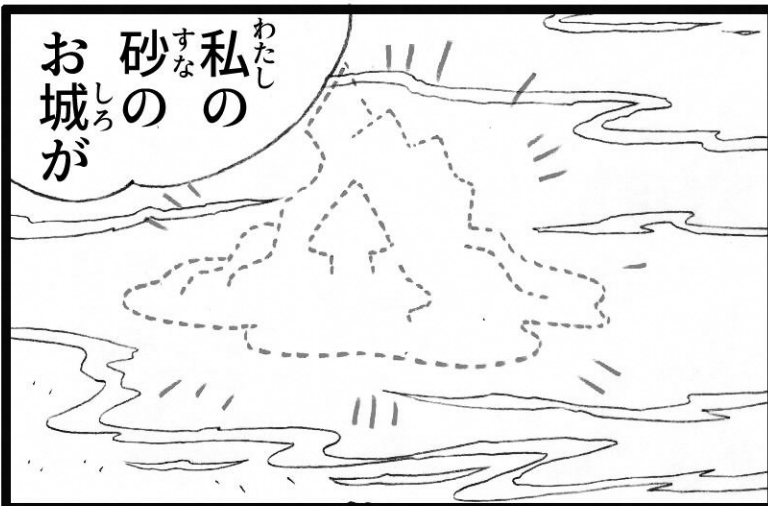

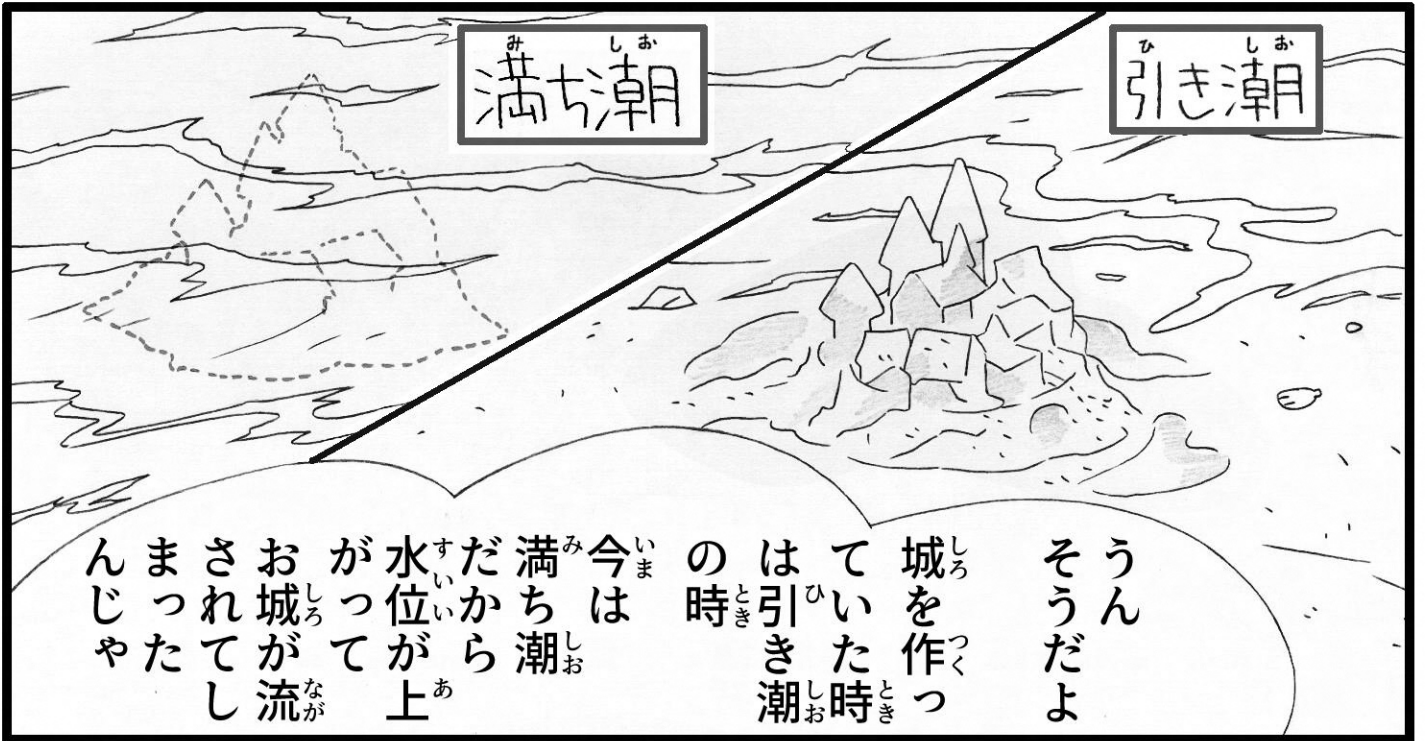

満ち潮

引き潮

うん そうだよ
 城を作った時
 ていた時
 は引き潮
 の時
 今満ち潮
 だから
 水位が上
 がって流
 お城が
 さらたし
 まった
 んじゃ



そうなん
 じゃ：



満ち潮？
 引き潮？

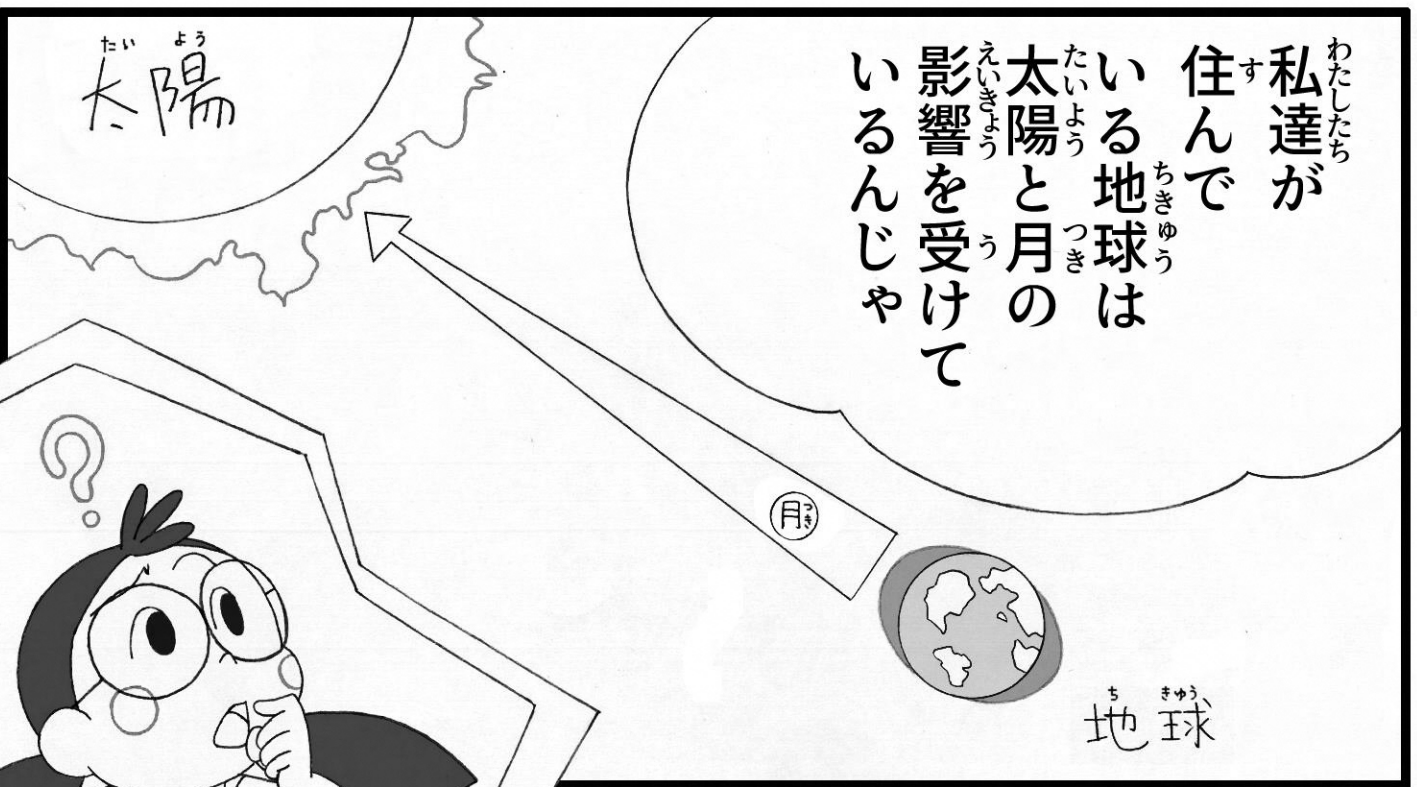

太陽

月

地球

私達が
 住んで
 いる地球は
 太陽と月の
 影響を受けて
 いるんじゃ



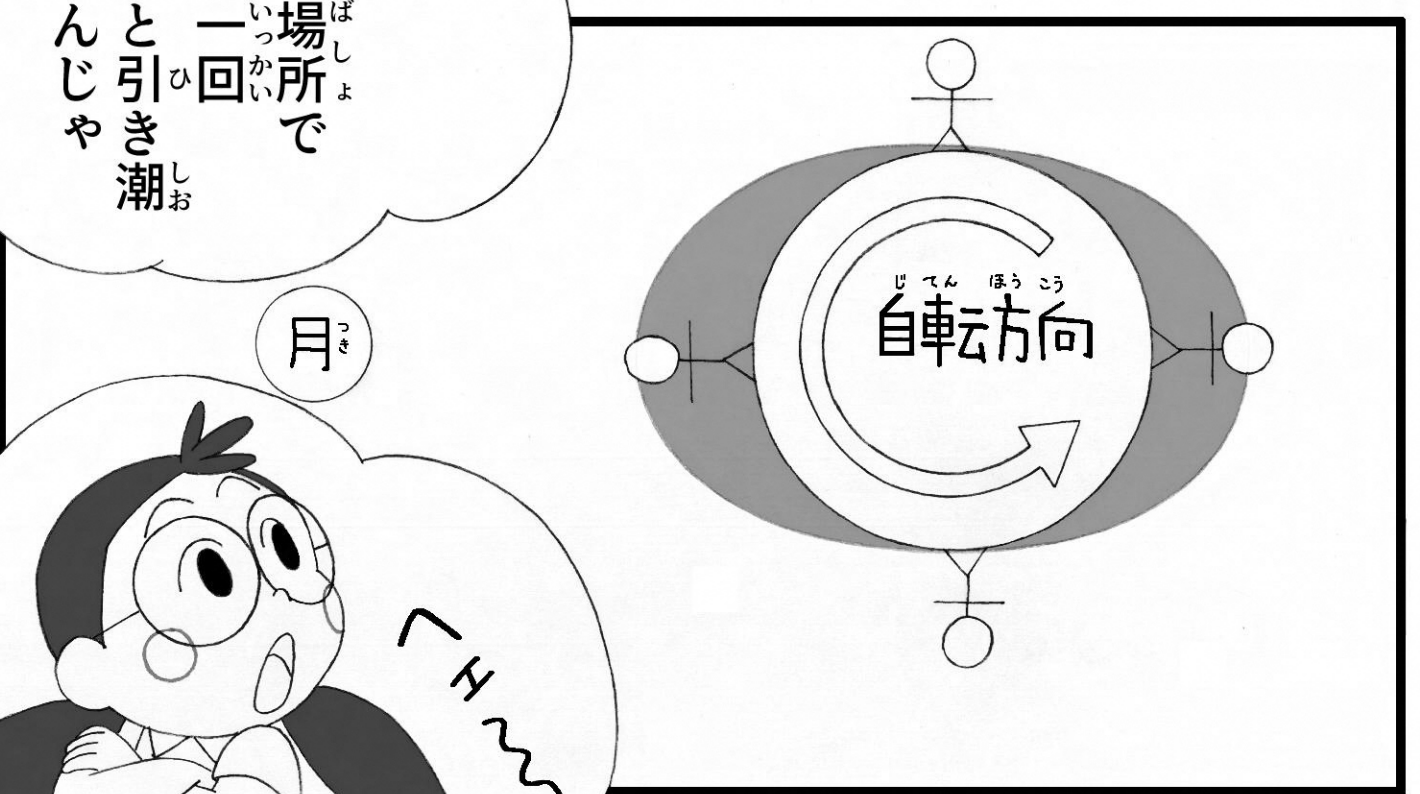
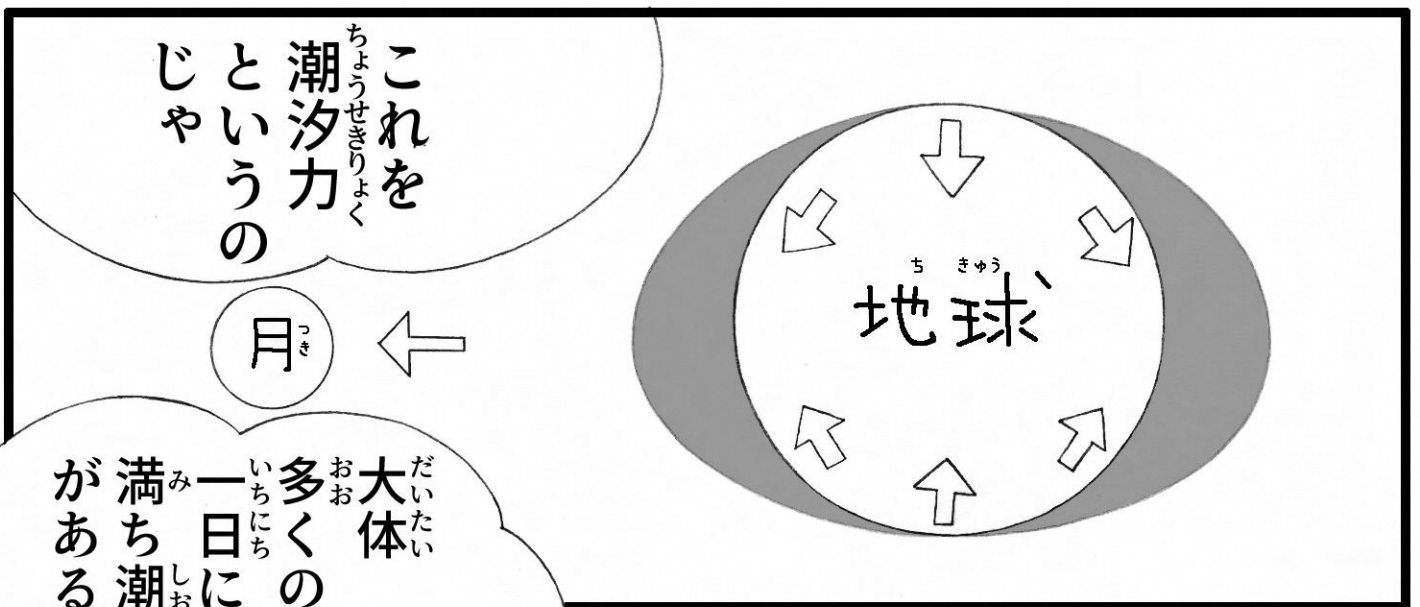
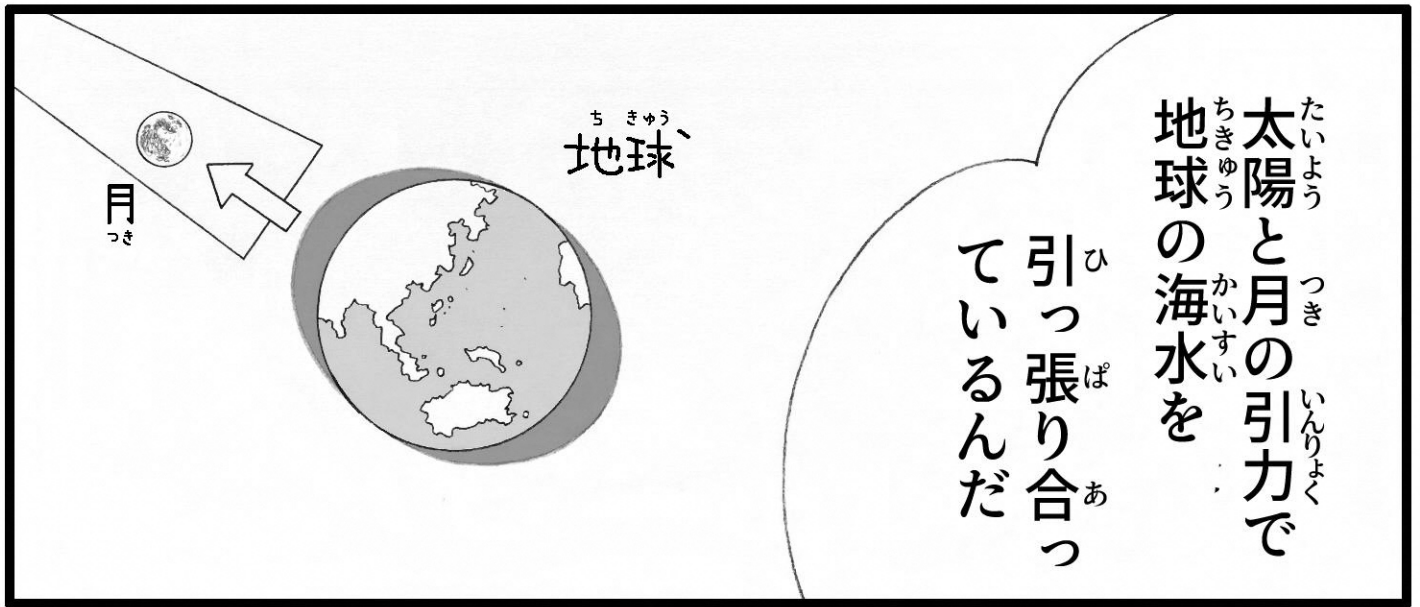

大体多くの場所では一日に一回満ち潮と引き潮があるんじゃないか

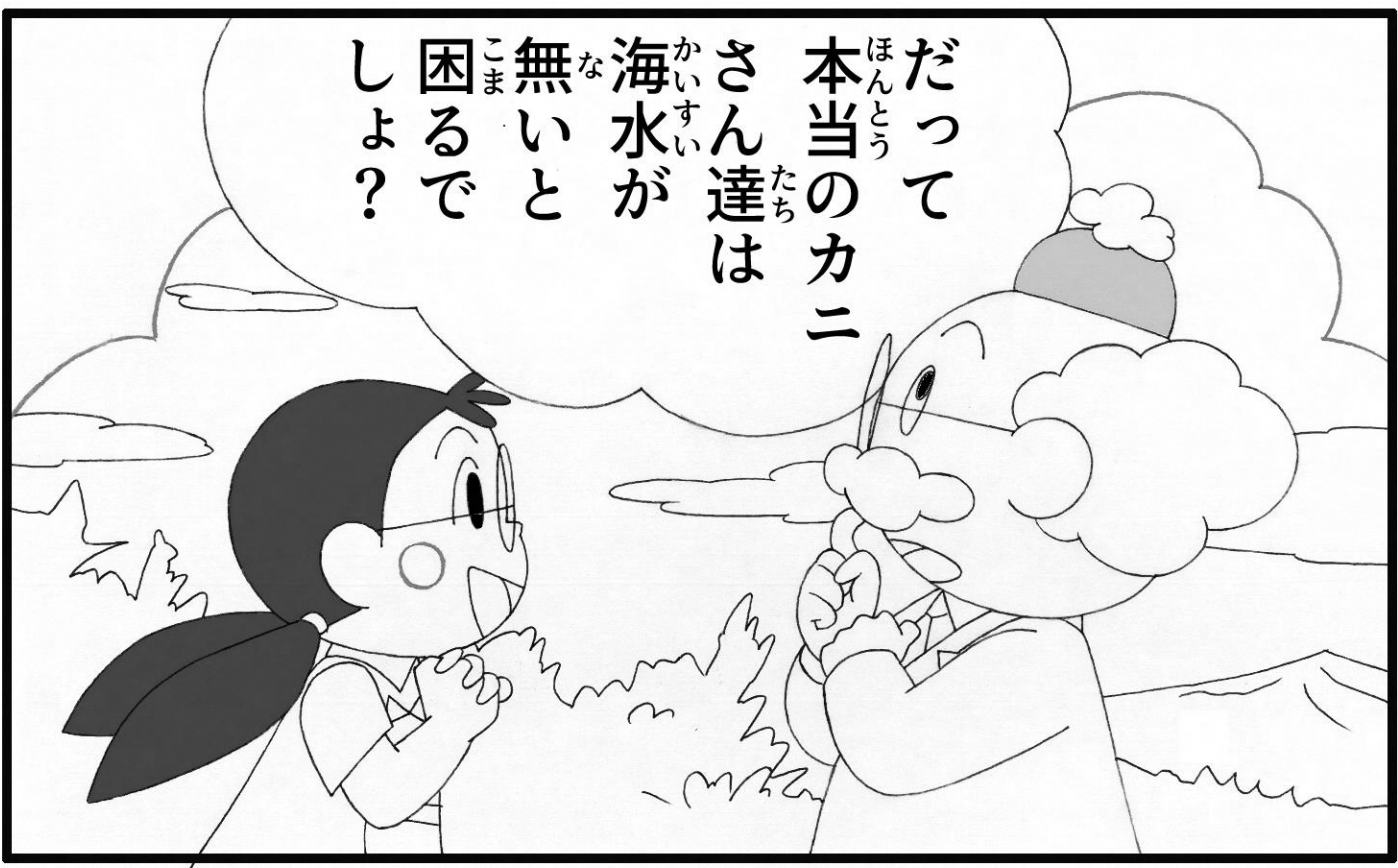

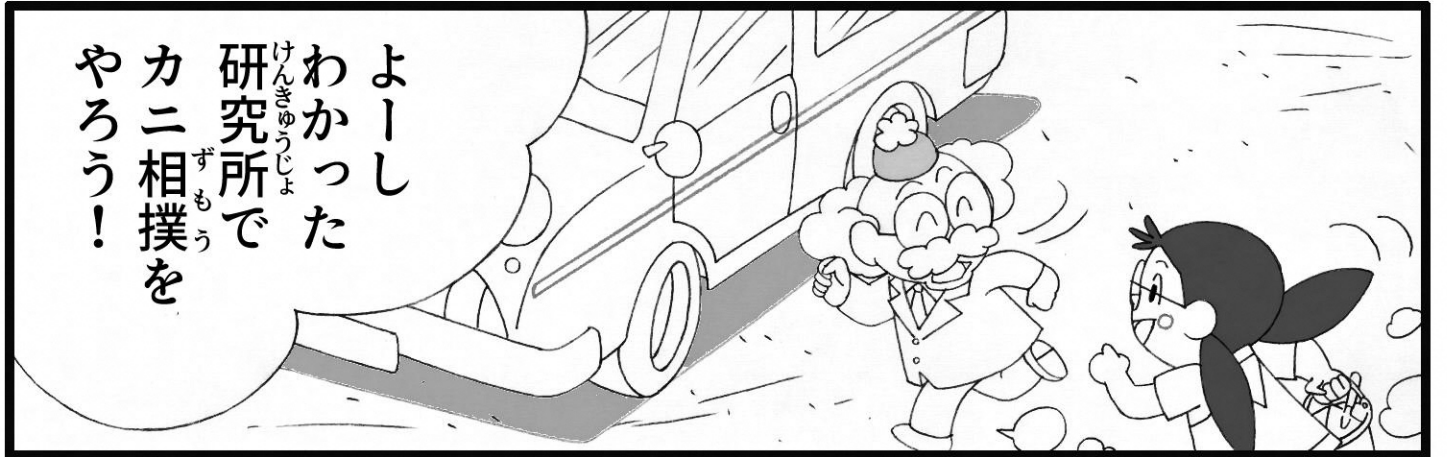

こうさくへん

カニずもう工作編

用意するもの

まずは
準備から
じゃ……

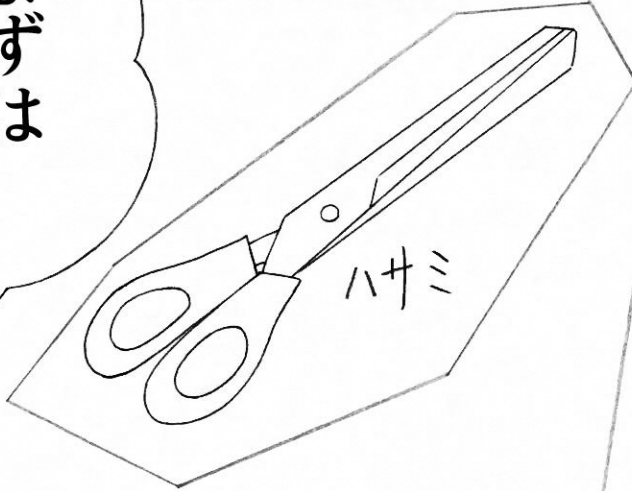

飲み終わった牛乳パック

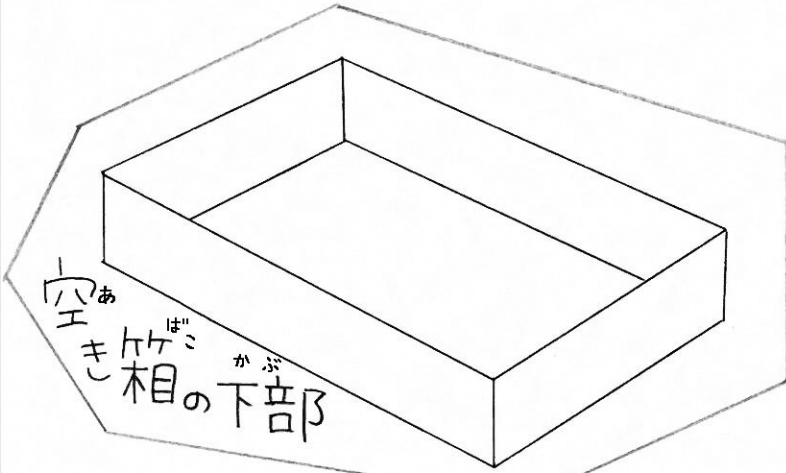

空の箱の下部

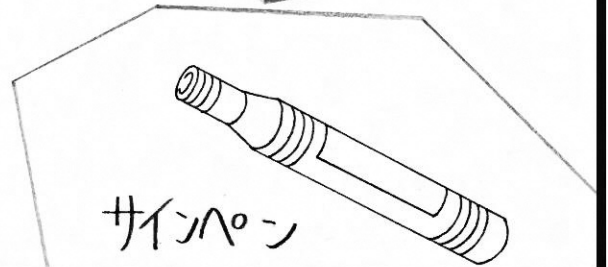

サインペン

4つの角にも切り込みを入れ

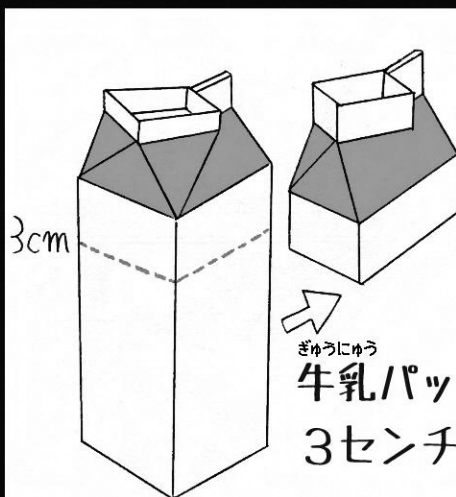
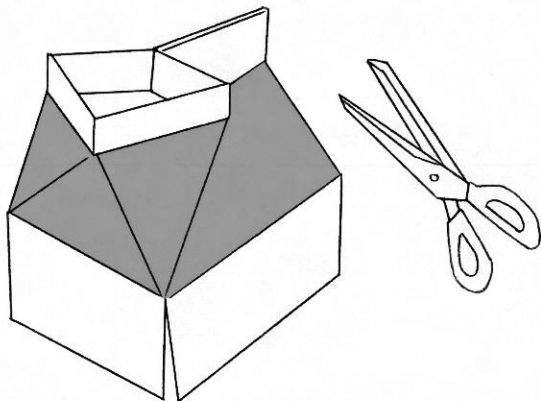

3cm

牛乳パックの上部を
3センチくらいカットする

では
作り方から
じゃ

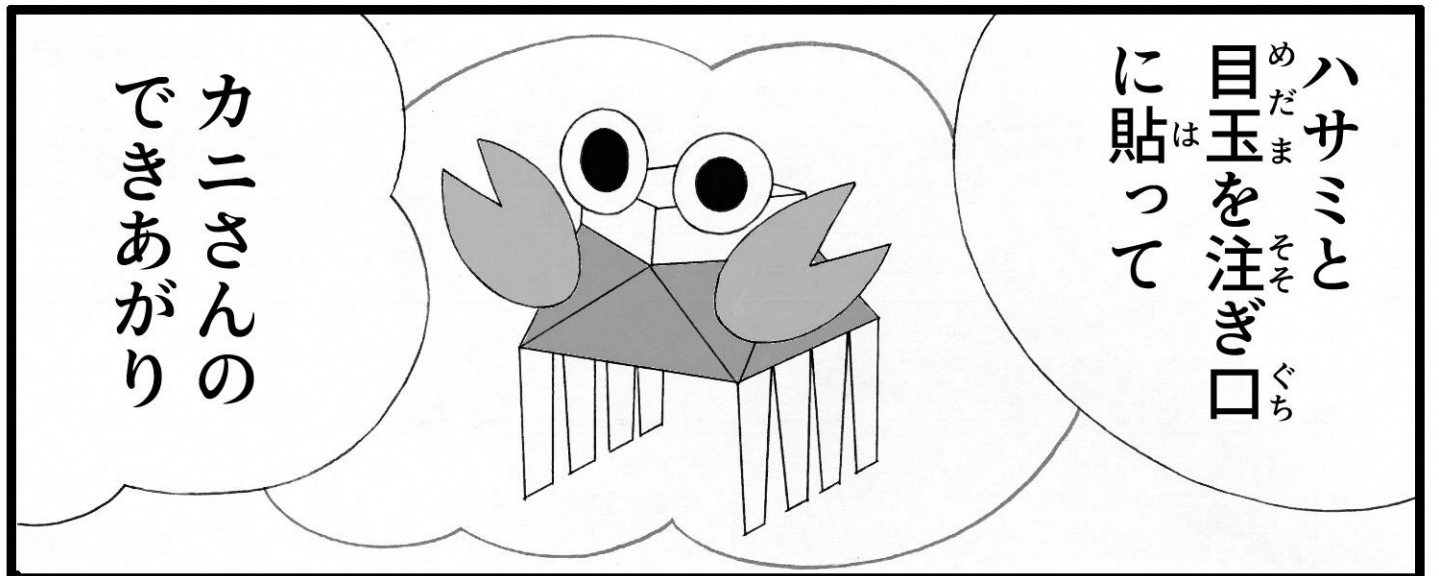
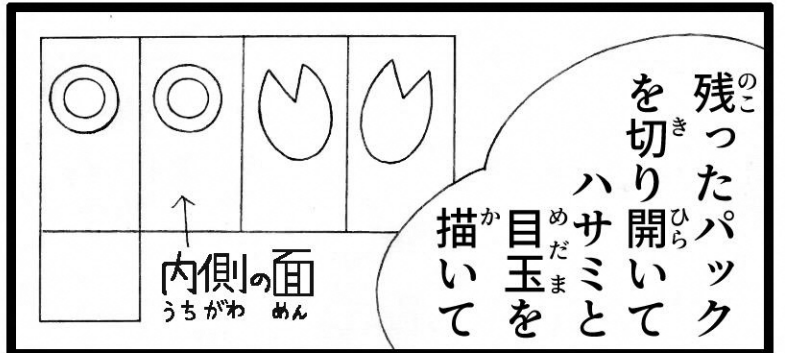
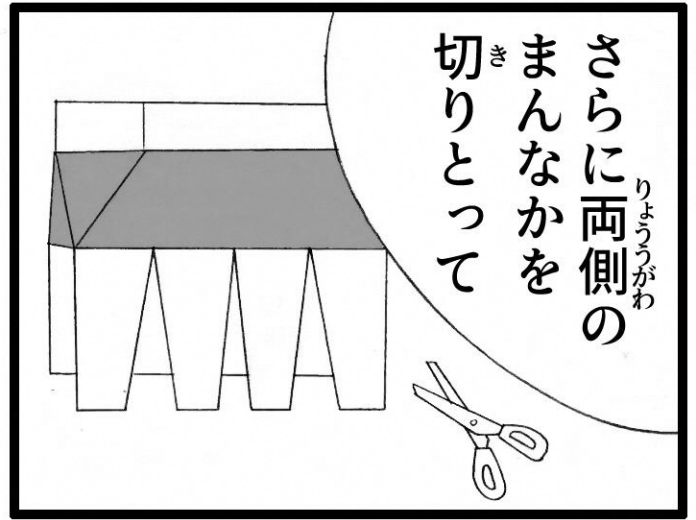
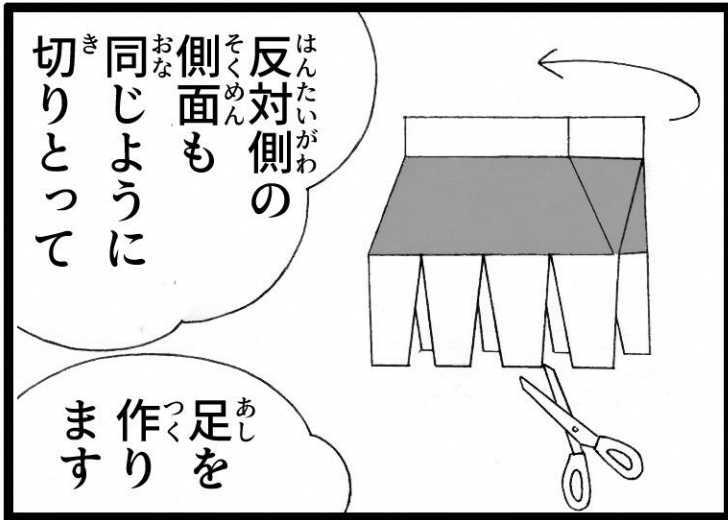
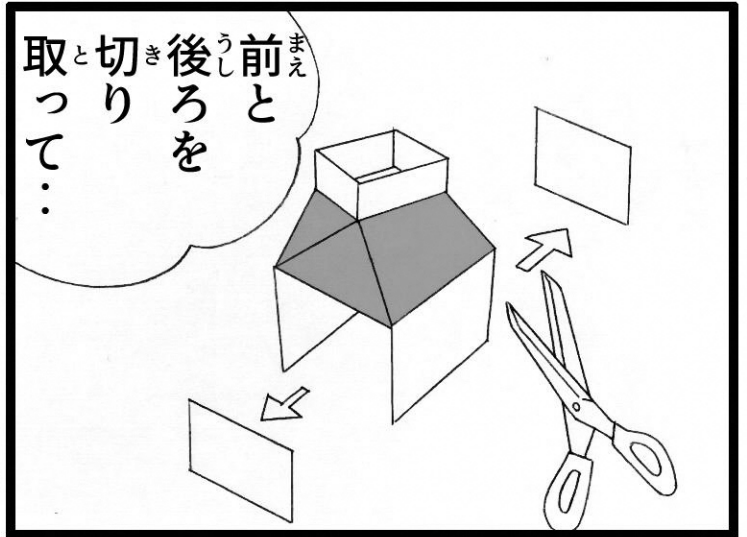

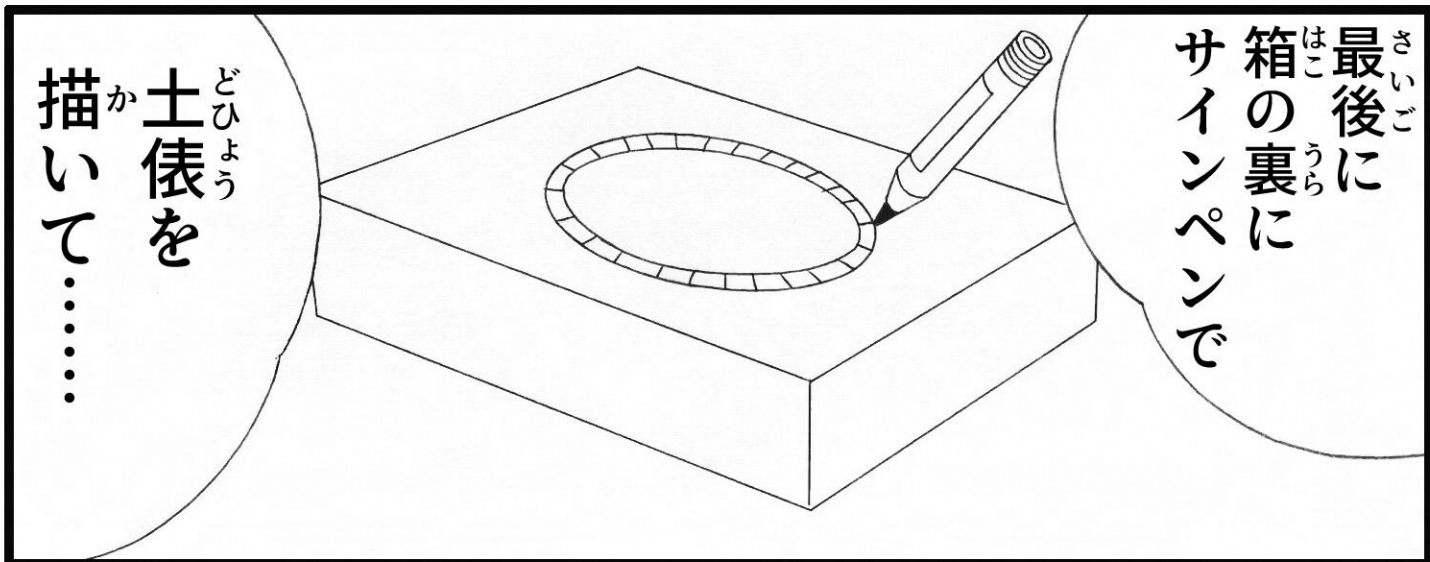

最後に
箱の裏に
サインペンで

どひよう
土俵を
か
描いて……

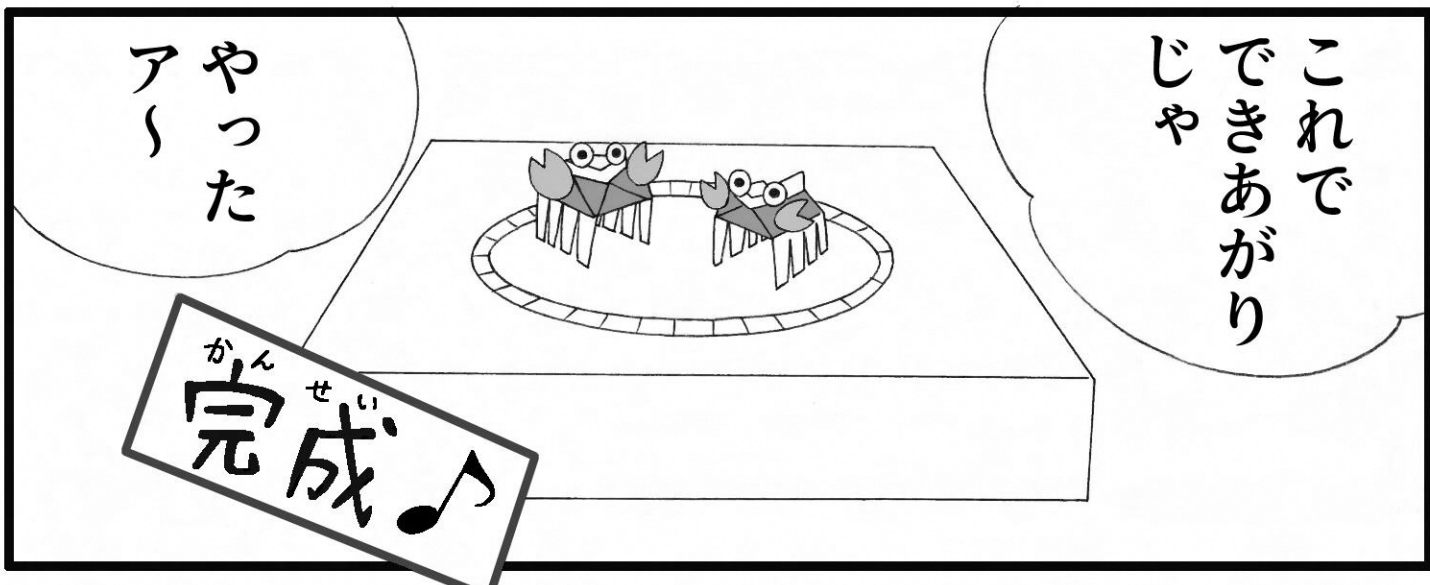

これで
できあがり
じゃ

やった
ア

かんせい
完成



それは
かんたん
簡単
じゃよ



博士
遊び方も
おし
教えて!

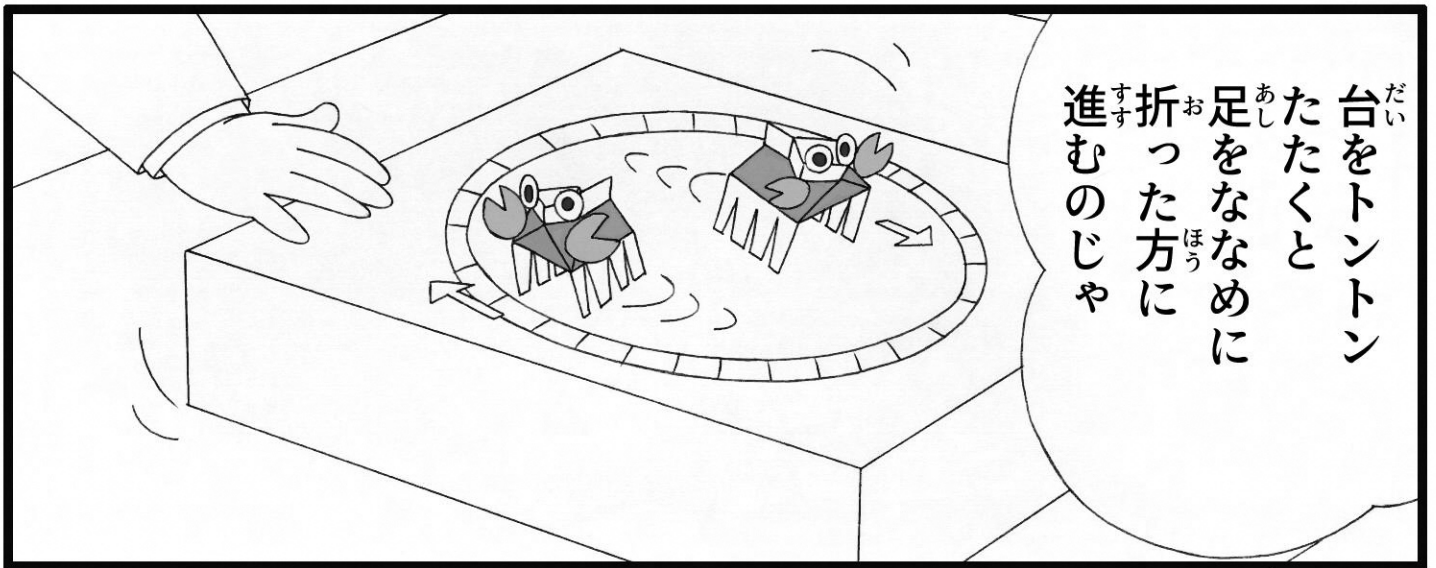

だい
台をトントン
たたくと
あし
足をななめに
お
折った方に
ほう
進むのじゃ



じゃみんなも
つく
作って
みて!



たの
楽しいぞ!
これをお友達と
ともだち
つく
作って遊んで
あそ
みしてくれ!